

SCUOLA PRIMARIA PONTE NUOVO . RAVENNA

LDA.iMdA ARCHITETTI (capogruppo)





CHI

LDA

.iMda

capogruppo

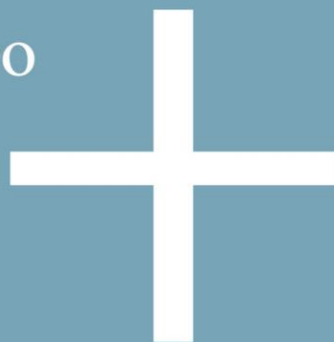

STUDIO TECNO srl

STUDIO MANNORI&associati geologia tecnica

arch. GIACOMO BENVENUTI

arch. EMMANUELE BORTONE

arch. NICO FEDI

arch. PAOLO OLIVERI

ing. SIMONE PAGNI

arch. DARIO VIVALDI



PER
CHI



DO
VE

PONTE NUOVO
RAVENNA



PNNR



UNA SCUOLA IN DUE SCUOLE



UNA SCUOLA IN UN'UNICA SCUOLA



SUPERFICIE COPERTA ~2400 MQ



SUPERFICIE COPERTA ~2500 MQ

COMPLETAMENTO DELL'OPERA ENTRO IL 30/06/2026!

SCUOLA CECI

DEMOLIZIONE
~ 730 MQ CIRCA





SCUOLA
GULMINELLI

DEMOLIZIONE
~ 1700 MQ CIRCA



IL PROGETTO

SCUOLA PRIMARIA
PONTE NUOVO RAVENNA

IN NUMERI
375 ALUNNI
15 AULE + 6 AULE SPECIALI

CIRCA IN METRI QUADRI
2990_{MQ} DIDATTICA
1400_{MQ} PALESTRA
=
~ 4390_{MQ} TOTALI

IN
ARMONIA
CON IL SUO
INTORNO

SCUOLA PRIMARIA

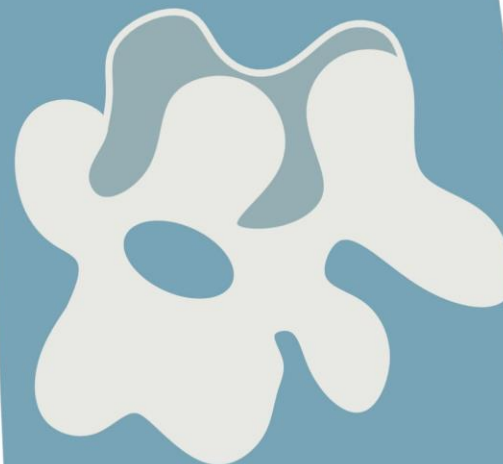
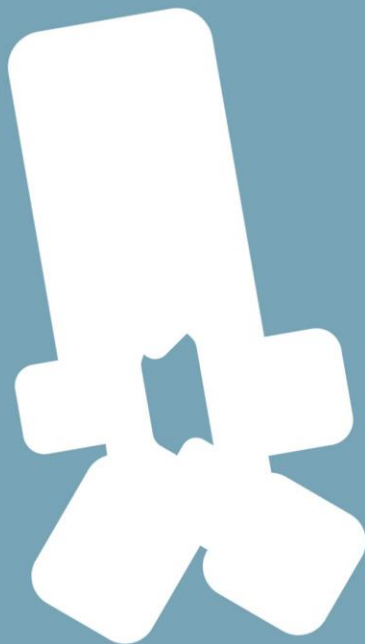

POLO 0-6

*oggetto di precedente
progetto-futura realizzazione
NON incarico LDA.iMdA

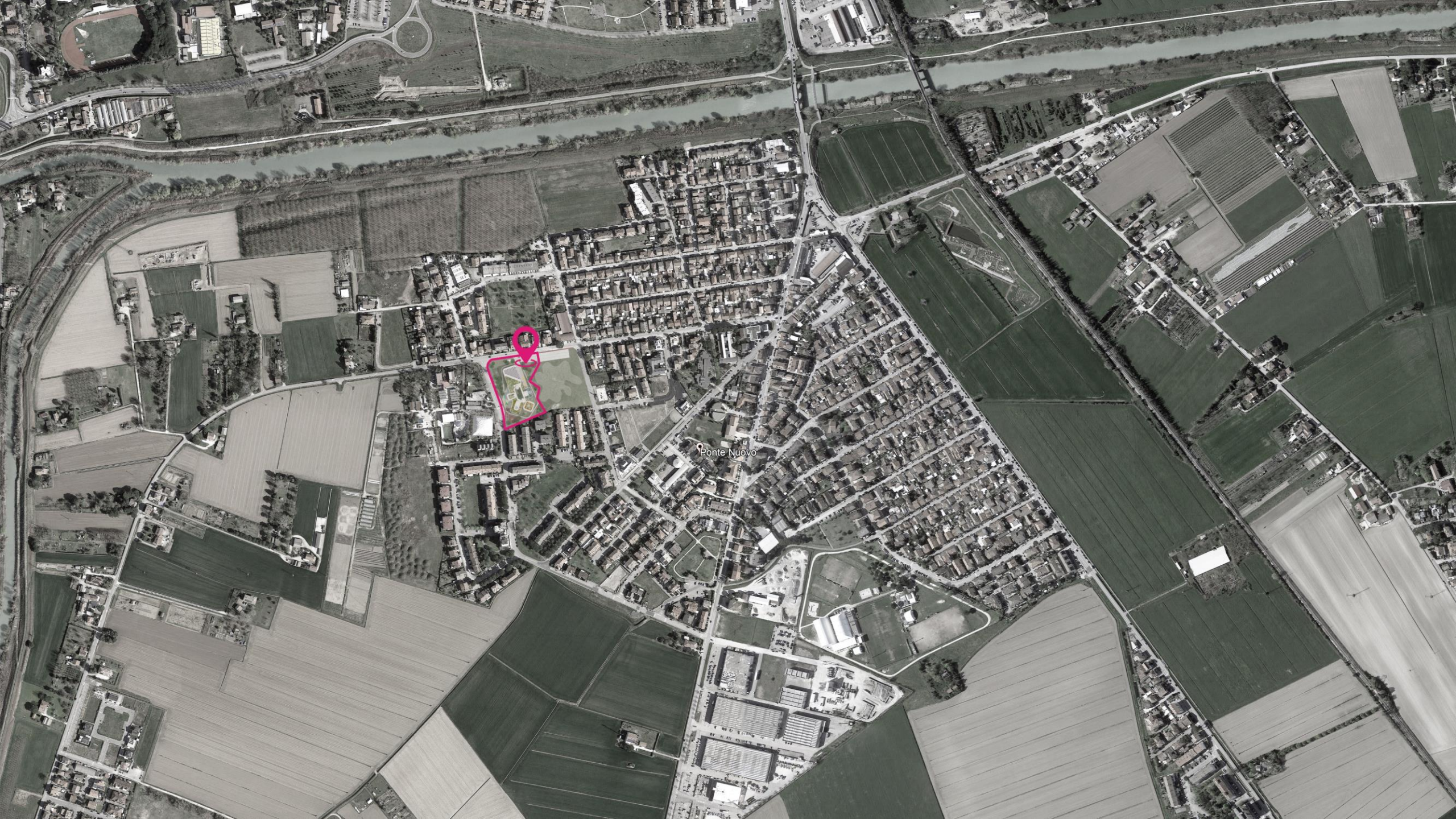

Ponte Nuovo





Scuola Primaria



Allium schoenoprosom



Dianthus carthusianorum



Aster amellus



Gallium verum



Aster linosyris



Gypsophila repens



Centaurea scabiosa



Leucanthemum vulgare



- 1 GIARDINO ROCCIOSO
- 2 GIARDINO DELLE ERBACEE SPONTANEE
- 3 GIARDINO DELLA LAVANDA
- 4 AREA GIOCHI ATTREZZATA
- 5 ATTIVITA' DIDATTICA ALL'APERTO
- 6 ATTIVITA' LUDICO MOTORIA
- 7 ORTI DIDATTICI
- 8 GIARDINO SENSORIALE

GIARDINO DELLE EMOZIONI

1. giardino roccioso
2. giardino erbacee
3. giardino lavanda
4. area giochi
5. didattica all'aperto
6. area ludico motoria
7. orti didattici
8. giardino sensoriale

ORGANIZZAZIONE DEGLI SPAZI ESTERNI

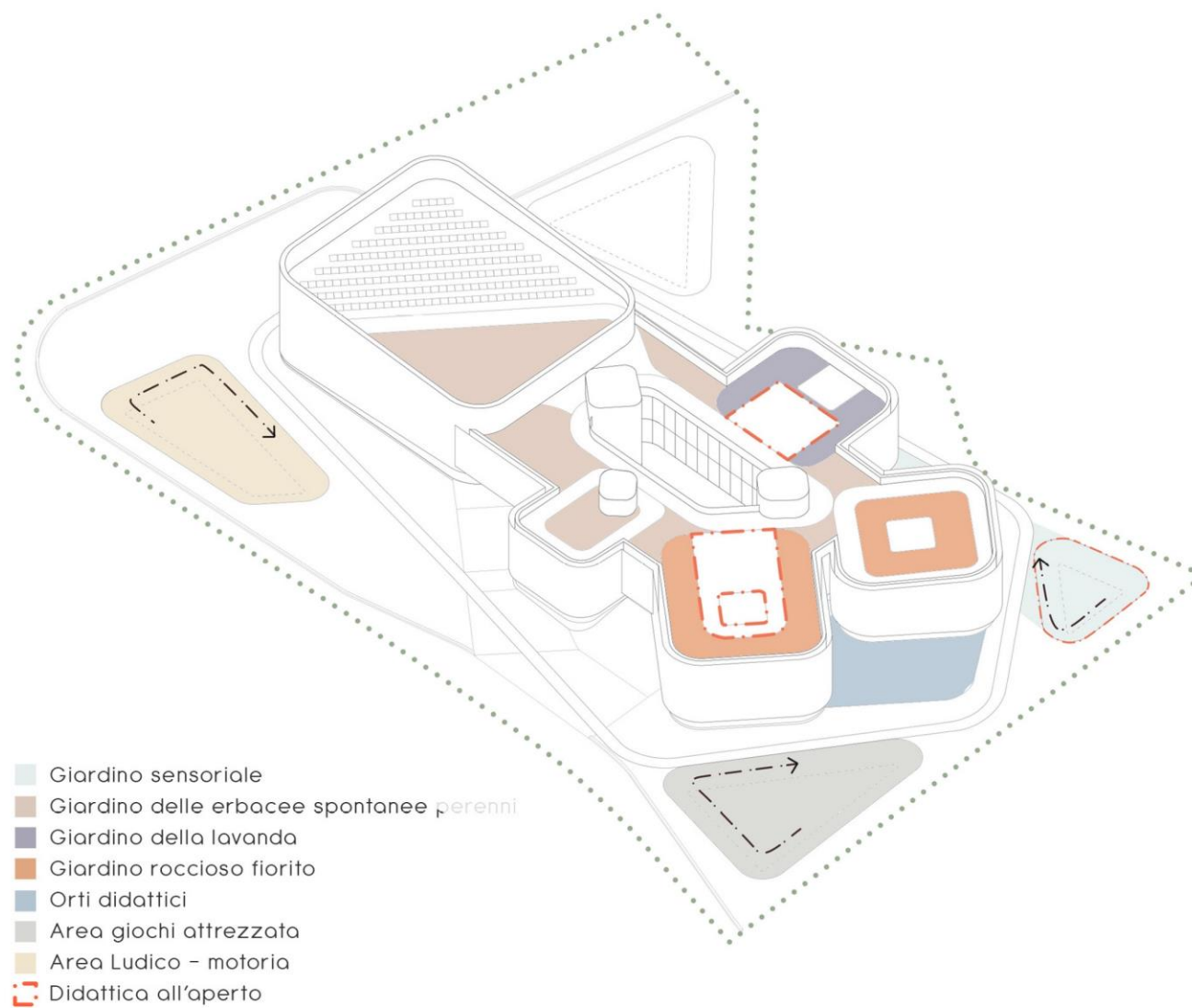

DEPRESSIONI
COMPENSATIVE

=

ATTENUARE
IL RISCHIO
IDRAULICO

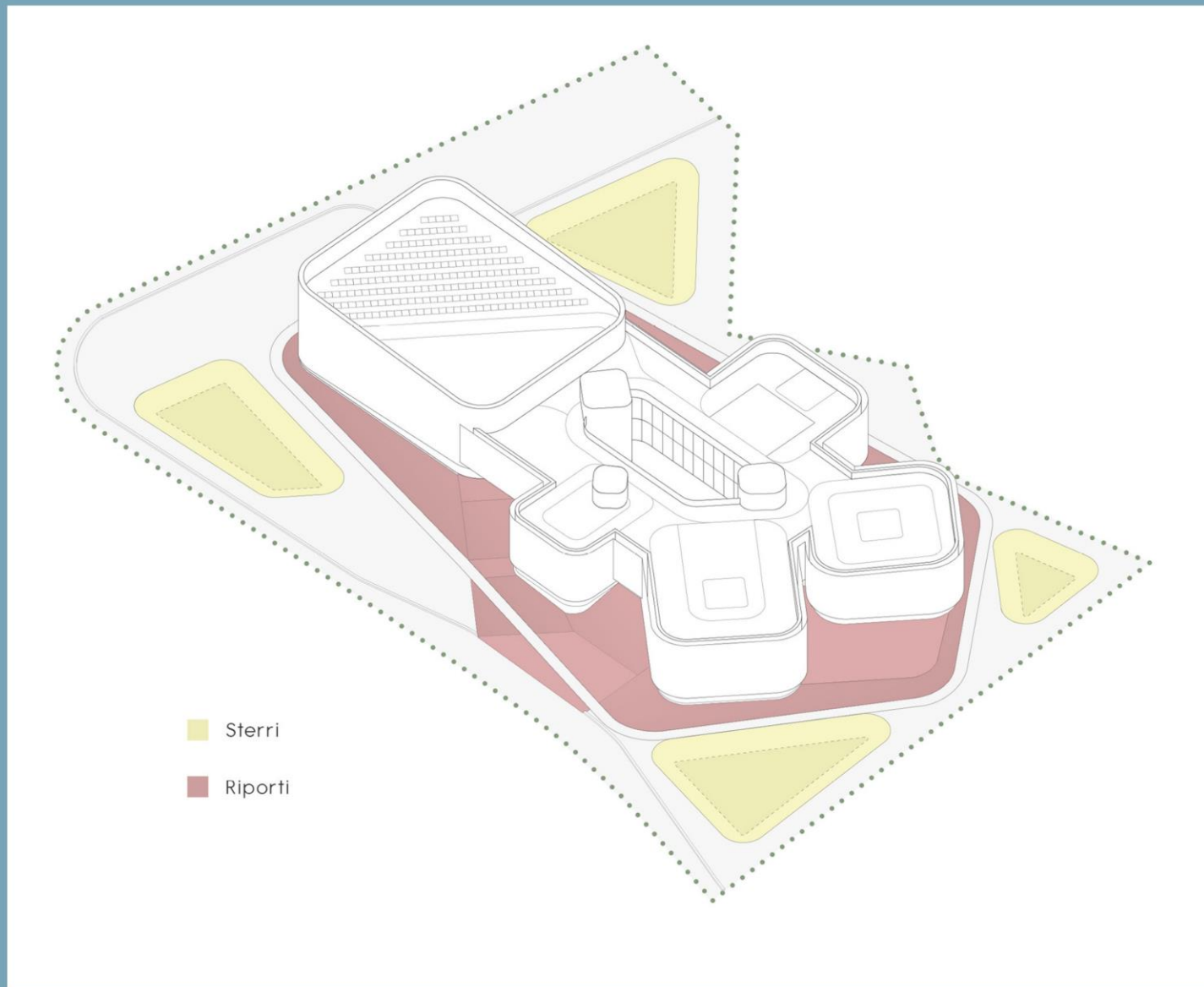

ACCESSIBILITÀ DELLE AREE ESTERNE

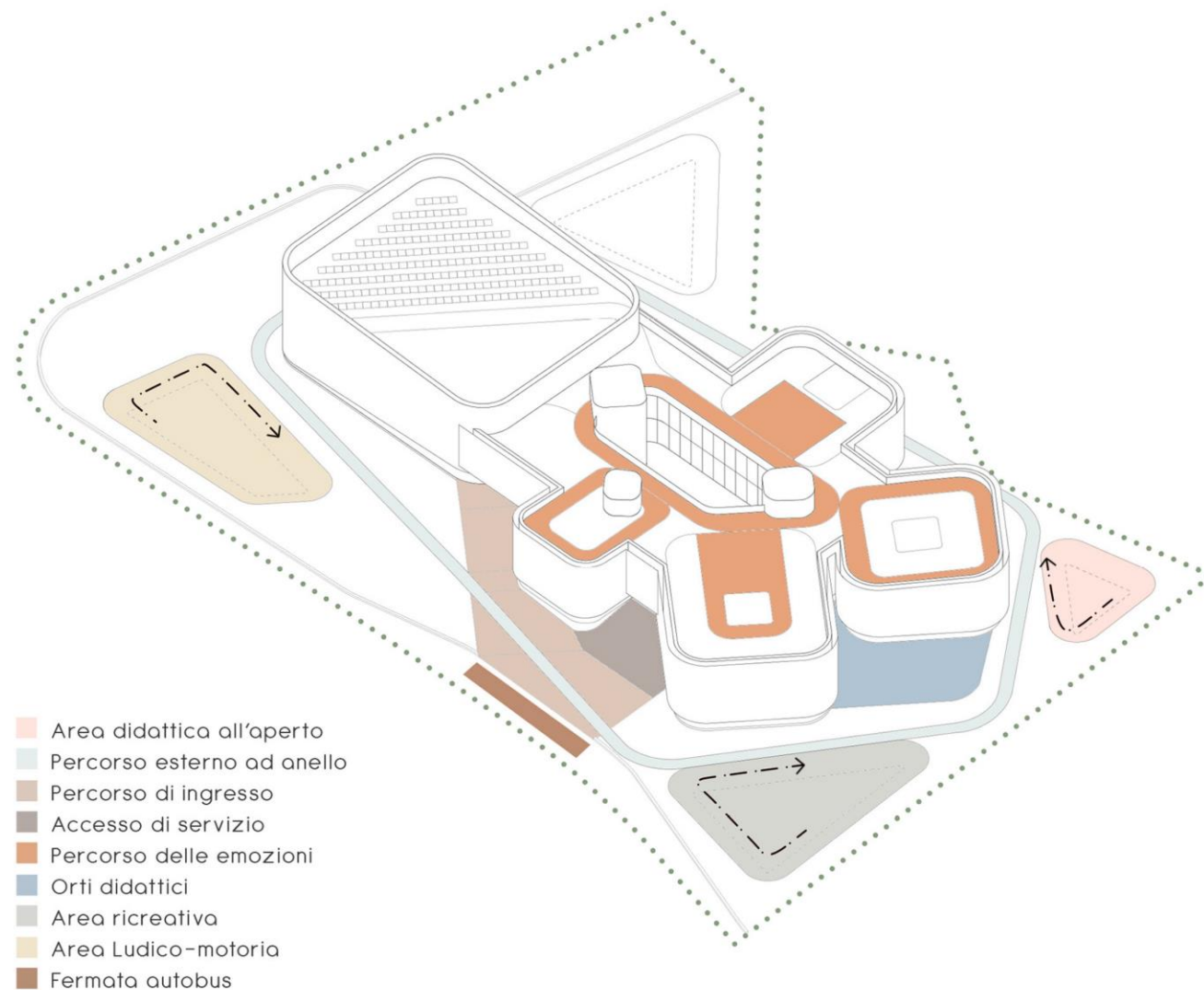

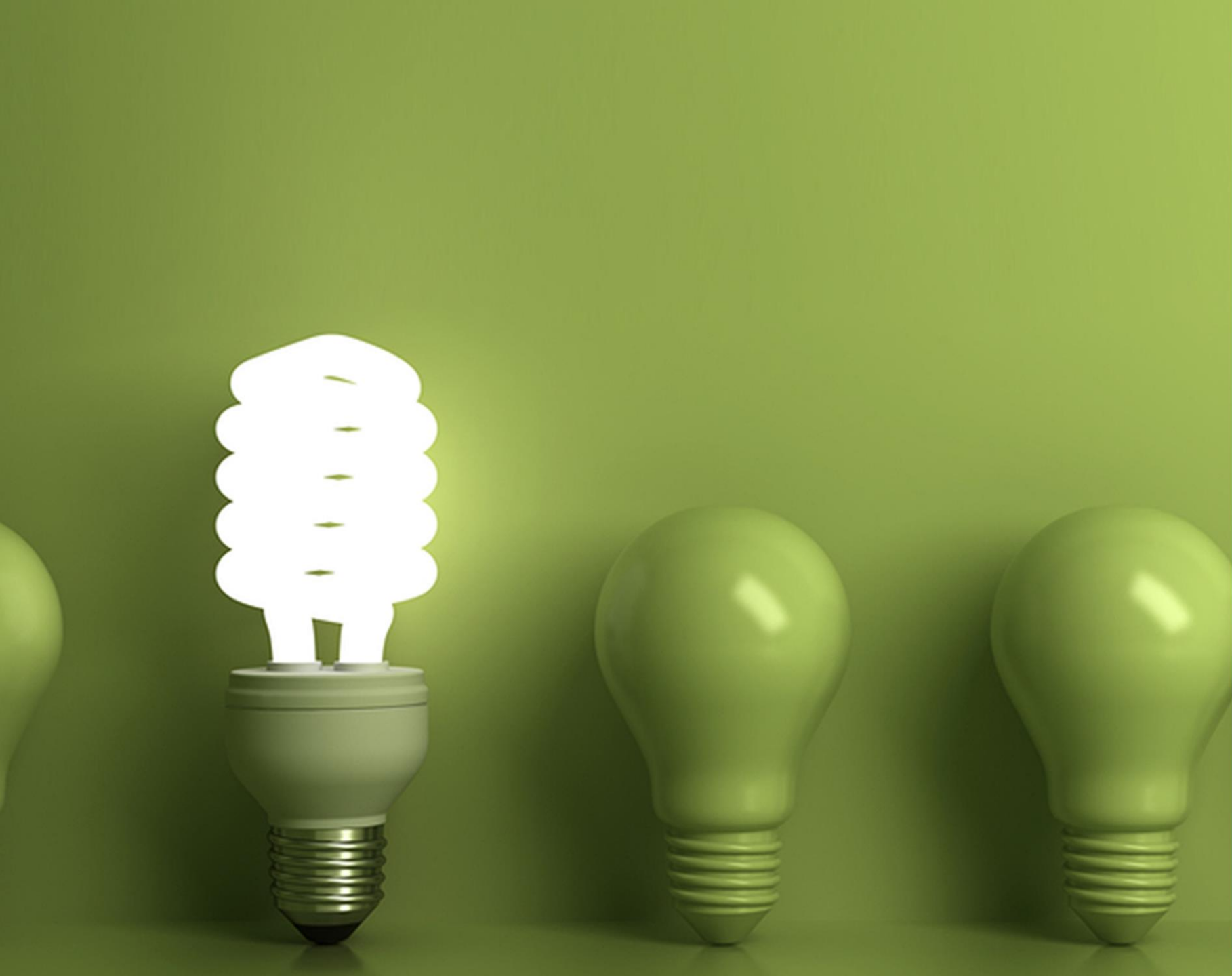

NZEB
ZERO

- 20%

930_{MQ DI}
FOTOVOLTAICO
(421 PANNELLI)



PRODURRANNO

~230_{MWH}

OGNI ANNO



ANALISI DEL SOLEGGIAMENTO



PROGETTO DELLE SCHERMATURE SOLARI

situazione estiva

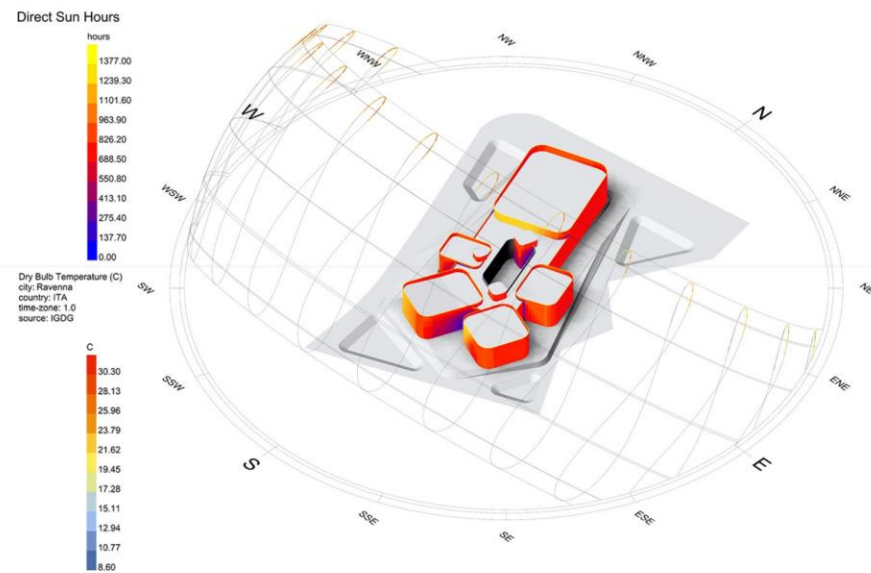

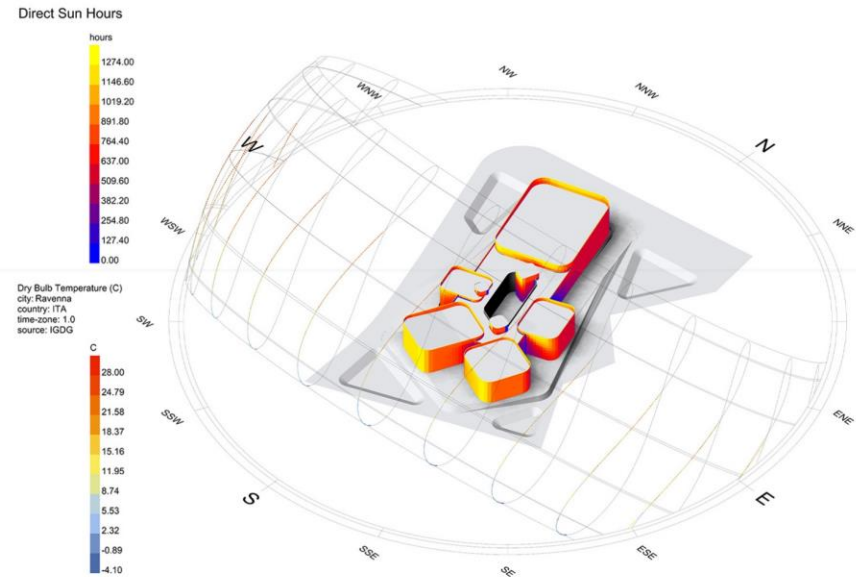

situazione invernale



ANALISI DEL SOLEGGIAMENTO



SCHEMATURE SOLARI ADATTIVE

-  schermature espanse e con profilo ridotto
-  schermature di raccordo
-  schermature contratte con profilo maggiorato

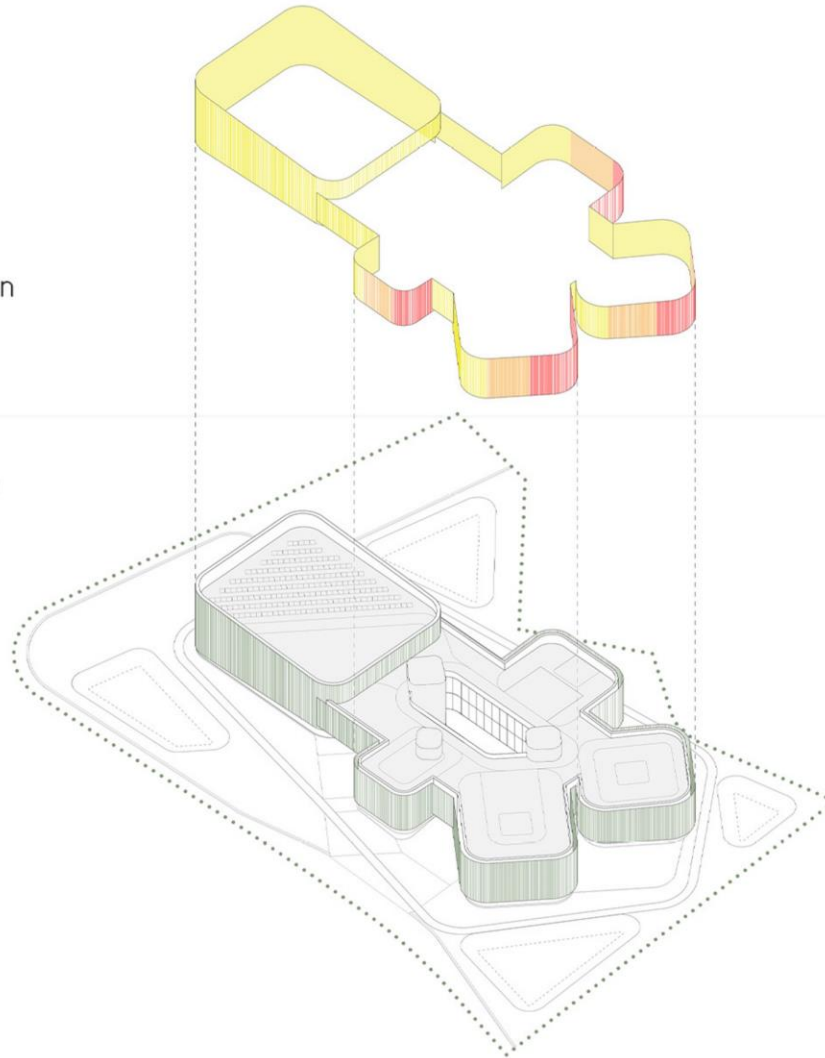

DEPRESSIONI
COMPENSATIVE



AREE LUDICO
MOTORIE





INVASO
DALLA
LUCE
NATURALE

ATTORNO
ALLA CORTE
CENTRALE



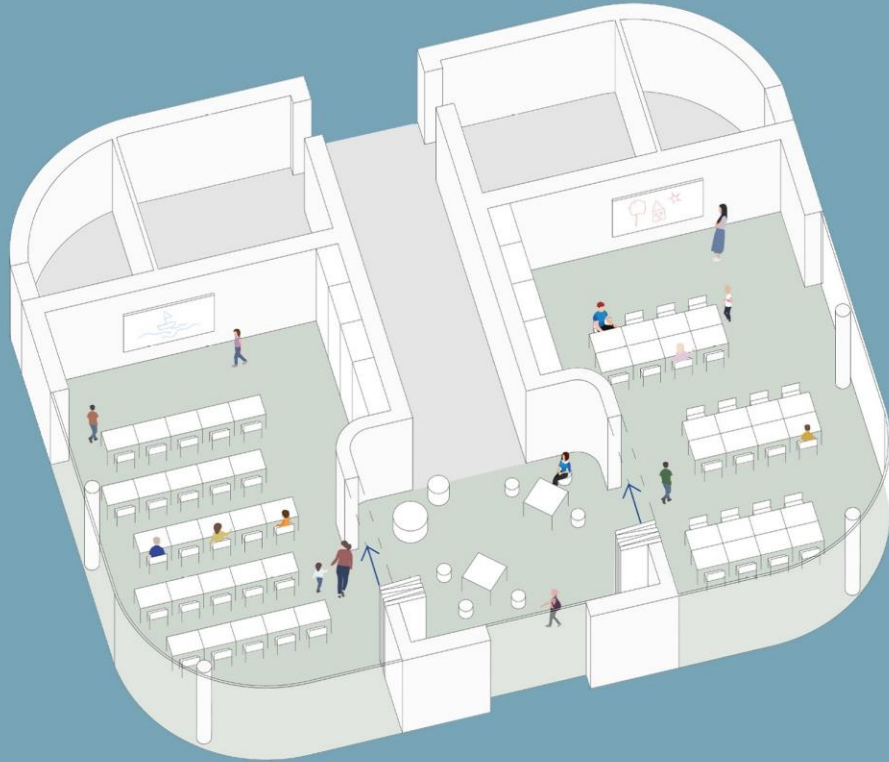

FLESSIBILE



FAVORIRE LE RELAZIONI



DIDATTICA ALL'APERTO

APERTA ALLA CITTÀ

MINIBASKET
PALLAVOLO E
TANTI ALTRI
SPORT + AMPIA
TRIBUNA
SPETTATORI



PIANTA PIANO TERRA

- 1 INGRESSO CONNETTIVO - 414 mq
- 2 BIDELLERIA / CONTROLLO ACCESSI - 26 mq
- 3 SERVIZI / SPOGLIATOI ADDETTI - 14 mq
- 4 SPAZI PER LA PULIZIA - 4 mq
- 5 AULA FLESSIBILE / BIBLIOTECA - 57 mq
- 6 LOCALE TECNICO - 2 mq
- 7 LOCALE DI SPORZIONAMENTO - 30 mq
- 8 DISPENSA - 8 mq
- 9 SERVIZI / SPOGLIATOI ADDETTI ALLA MENSA - 7 mq
- 10 MENSA - 280 mq
- 11 AULA DIDATTICA O1 - 56 mq
- 12 AULA DIDATTICA O2 - 56 mq
- 13 AULA DIDATTICA O3 - 56 mq
- 14 AULA DIDATTICA O4 - 56 mq
- 15 AULA DIDATTICA O5 - 56 mq
- 16 AULA FLESSIBILE - 31 mq
- 17 AULA DIDATTICA O6 - 56 mq
- 18 SERVIZI STUDENTI - 25 mq
- 19 LOCALE TECNICO - 13 mq
- 20 PALESTRA - 610 mq
- 21 DISTRIBUTIVO PALESTRA - 98 mq
- 22 DEPOSITO - 7 mq
- 23 SPOGLIATOI ARBITRI / INSEGNANTI CON SERVIZI - 32 mq
- 24 SPOGLIATOI STUDENTI CON SERVIZI - 52 mq
- 25 INFERMERIA 15 mq
- 47 AREA DIDATTICA INFORMALE - 25 mq
- 48 SOTTOCENTRALE IMPIANTISTICA - 25 mq

■ SETTI IRRIGIDENTI

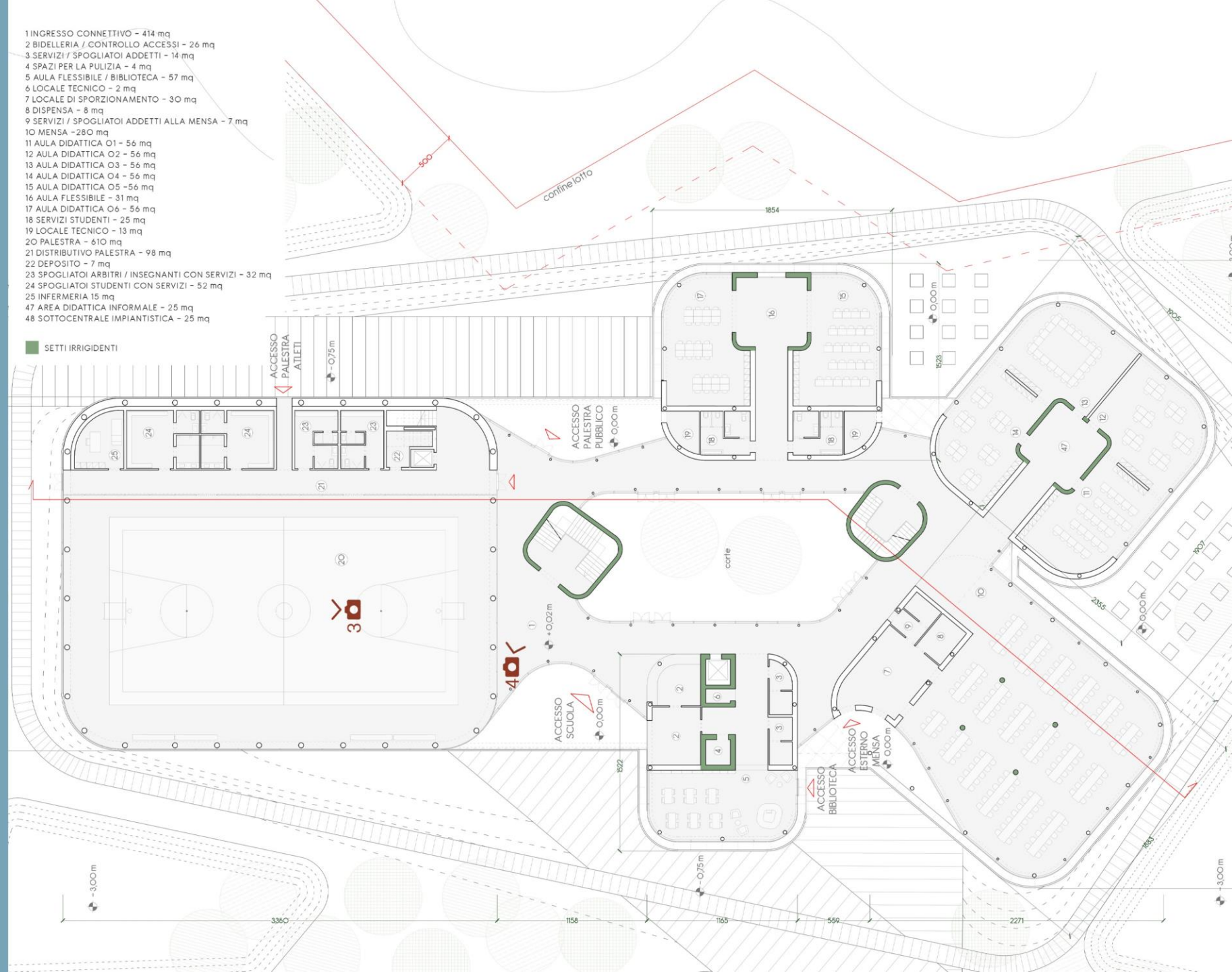

PIANTA PIANO PRIMO

- 26 SERVIZI STUDENTI - 12,5 mq
- 27 SPAZIO MORBIDO - 28 mq
- 28 SALA INSEGNANTI - 54 mq
- 29 SERVIZI / SPOGLIATOI INSEGNANTI - 14 mq
- 30 AULA INFORMATICA - 60 mq
- 31 AULA FLESSIBILE - 31 mq
- 32 AULA DIDATTICA 07 - 55 mq
- 33 AULA DIDATTICA 08 - 55 mq
- 34 AULA DIDATTICA 09 - 55 mq
- 35 SPAZIO MORBIDO - 32 mq
- 36 AULA DIDATTICA 10 - 54 mq
- 37 AULA DIDATTICA 11 - 54 mq
- 38 AULA DIDATTICA 12 - 54 mq
- 39 AULA DIDATTICA 13 - 54 mq
- 40 SERVIZI STUDENTI E DEPOSITO - 19 mq
- 41 SERVIZI STUDENTI E DEPOSITO - 19 mq
- 42 AULA DIDATTICA 14 - 54 mq
- 43 AULA FLESSIBILE - 31 mq
- 44 AULA DIDATTICA 15 - 54 mq
- 45 SERVIZI IGIENICI PUBBLICO - 16 mq
- 46 TRIBUNA - 170 mq
- 47 AREA DIDATTICA INFORMALE - 361 mq

■ SETTI IRRIGIDENTI

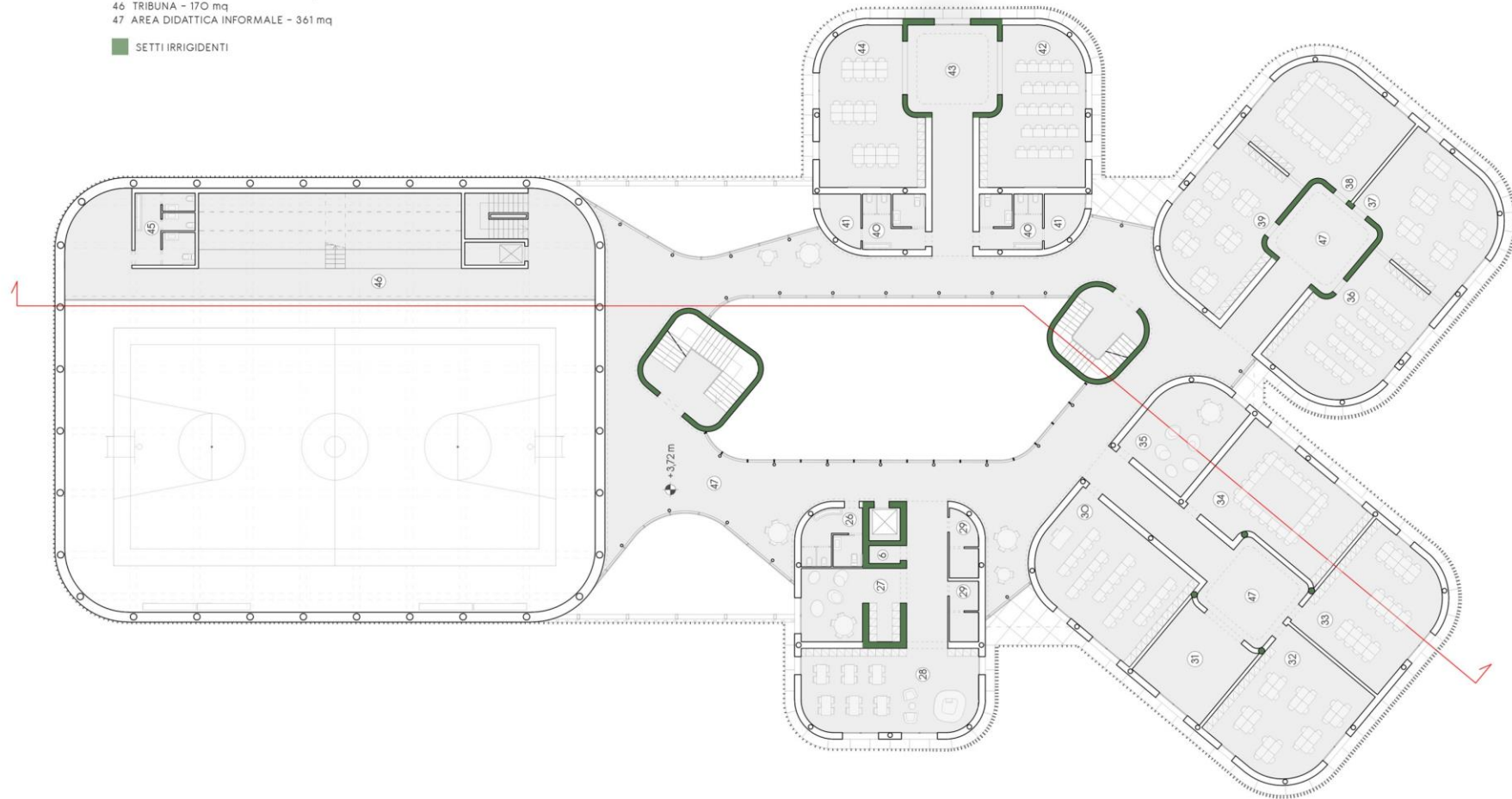



...ED I

RAGAZZI

COME LA

VIVRANNO ?

